

Ferrite for Telecommunication

Summary

Ferrite is a polycrystal, sintered material with high electrical resistivity. The high resistance of ferrite makes eddy current losses extremely low at high frequencies. Therefore, unlike other magnetic components, ferrite can be used at considerably high frequencies. Manganese-zinc(Mn-Zn) ferrites can be used at frequencies up to several megahertz.

The basic ferrite materials are obtained in an extremely high purity. These materials are mixed, calcined, milled, granulated, formed by pressing, and sintered at a temperature of 1000°C to 1400°C, then machined. The electrical and mechanical properties of a particular ferrite material are obtained by the material formulation and the processing applied. Extraordinary exacting process controls are required to assure the high uniformity of product for which TDK ferrites are well known. Through the above processes, ferrite materials can be optimized for specific applications.

Each of these materials can be produced in cores of various shapes. Shapes which are popular for the listed applications are:

APPLICATIONS, CHARACTERISTICS AND TDK CORE TYPE

Applications	Ferrite characteristics	TDK core type
Filters	Low loss, magnetic stability, high permeability	Pot and RM cores
Signal transformers	High saturation flux density, high permeability	EP, EE, Pot and RM cores
Power conversion transformers	High saturation flux density, low power loss	EI, EC, Pot and RM cores

TDK produces a very large variety of cores and magnetic properties. Nearly every requirement can be satisfied among these products.

TYPICAL TECHNICAL DATA

Dielectric constant	Mn-Zn ferrite 240 to 300 Ni-Zn ferrite 10 to 13
Specific heat	800(J/kg • °C)
Thermal conductivity	1 to 5(W/m • °C)
Coefficient of thermal linear expansion	7 to 10(ppm/°C)
Modulus of elasticity	1.2×10^{11} (N/m ²)
Vickers hardness	550
Tensile strength	100(kg/cm ²)
Bending strength(50mm span)	100(kg/cm ²)
Young's modulus	11×10^3 (kg/mm ²)

• These values are typical at room temperature.

TERMS DEFINITIONS AND EXPLANATIONS

1. PERMEABILITY

1.1 INITIAL PERMEABILITY, μ_i

The initial permeability of a material is determined by the following formula, on the basis of the effective self-inductance exhibited by a test coil for a low AC magnetic field induced (approx.: 0.4A/m max.) in the toroidal core which is made of that material and on which the test coil is wound: (Fig. 1)

$$\mu_i = \frac{L}{4\pi N^2} \cdot \frac{\ell}{A} \cdot 10^{10}$$

where, L = effective self-inductance(H)

N = number of turns

ℓ = average length of magnetic path in the core(mm)

A = cross-sectional area of toroidal cores(mm²)

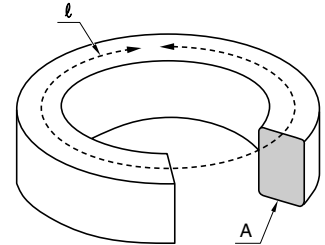

Fig. 1

1.2 INCREMENTAL PERMEABILITY, μ_Δ , AND REVERSIBLE PERMEABILITY, μ_{rev}

Incremental permeability is determined by the following formula and is defined as the permeability of a material to a low AC magnetic field superposed on a larger DC magnetic field:

$$\mu_\Delta = \frac{\Delta B}{\Delta H}$$

where, ΔB = incremental flux density(gauss)

ΔH = incremental field intensity(oersted)

Reversible permeability is defined as the limiting value of incremental permeability occurring at the zero amplitude of the alternating magnetic field. It is a function of the DC flux density B and takes the maximum value when B is the zero. Its value decreases as B increases.

Since the DC flux density varies with the core shape and also with the magnitude of the gap, it is not proper to apply a reversible permeability determined on a toroidal core to cores of other shapes such as E type, P type, etc. Hence, values of reversible permeability are determined separately for individual core shapes and gaps.

1.3 EFFECTIVE PERMEABILITY, μ_e

The effective permeability is determined by the following formula:

$$\mu_e = \frac{L \times 10^{10}}{4\pi N^2} \cdot \sum \frac{\ell}{A}$$

where, L = effective self-inductance(H)

N = number of turns

$\sum \frac{\ell}{A} = C_1 =$ core constant(mm⁻¹)

This formula is used also when some leakage flux exists in the magnetic circuit due to an air gap introduced in it.*

Note* :Magnetic-core loss coefficient, temperature coefficient, disaccommodation and other magnetic characteristics due to an air gap in the magnetic circuit very nearly directly with effective permeability, as long as the leakage flux at the air gap is not appreciably large. If the leakage is not negligible, a correction must be made on these characteristics for the leakage flux.

1.4 APPARENT PERMEABILITY, μ_{app}

Apparent permeability is defined as the ratio of the two inductance values measured. One on the test coil only(L_0), the other on coil and core(L). This is determined by the following formula:

$$\mu_{app} = \frac{L}{L_0}$$

where, L = inductance of test coil with core(H)

L_0 = inductance of test coil without core(H)

Normally, an apparent effective permeability refers to an open magnetic circuit.

2. MAGNETIZATION CURVE

2.1 STATIC MAGNETIZATION CURVES

In magnetic material that has been completely demagnetized, the curve traced by the rising value of flux density B as a function of the field intensity H being raised from the point of origin(0) is referred to as INITIAL MAGNETIZATION CURVE.

If field intensity is raised further, a point will be reached where the material becomes saturated with flux and the curve levels off: the SATURATION FLUX DENSITY, B_{sat} , refers to that value of flux. As the field intensity is reduced to zero from the saturation point, the flux density decreases and settles at a certain value above zero: this value of remaining flux density is referred to as REMANENCE, B_r . To reduce the remanence to zero, field intensity must be increased in the negative(reverse) direction: the level of this reversed field intensity required for reducing remanence to zero is termed COERCIVITY, H_{CB} .

2.2 RELATIONSHIP BETWEEN HYSTERESIS LOOP AND PERMEABILITY

Graphic models of initial permeability and reversible permeability as concepts are given on the magnetization curve in Fig.2.

The constants relative to magnetization curve are graphically represented in Fig.3.

$$\mu_{rev} = \lim_{\Delta H \rightarrow 0} \frac{\Delta B}{\Delta H} = \tan \theta_r$$

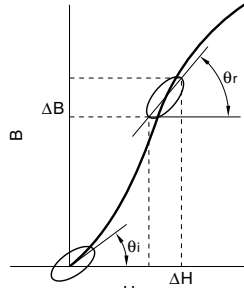

Fig. 2

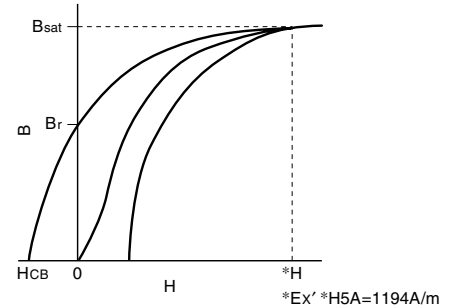

Fig. 3

3. CORE LOSS

3.1 LOSS FACTOR, $\tan \delta$

Core-loss factor, $\tan \delta$, is defined as the ratio of core-loss resistance to reactance, and consists of three components; namely, hysteresis loss, eddy-current loss and residual loss, and is expressed by the following formula:

$$\tan \delta = \frac{R_m}{\omega L} = h_1 \sqrt{\frac{L}{V}} i + e_1 f + c_1$$

where, R_m = core-loss resistance(Ω)

$\omega = 2\pi f$, angular velocity(radians/sec.)

L = inductance of test coil with core(H)

V = volume of core(cm^3)

f = frequency of test current(Hz)

h_1 = hysteresis loss coefficient

e_1 = eddy-current loss coefficient

c_1 = residual loss coefficient

i = current(A)

The loss factor is normally determined by effecting measurement with a small magnetic field, and is treated as a loss distinct and apart from the hysteresis loss. In other words, the loss coefficient is defined by the following formula:

$$\tan \delta = e_1 f + c_1$$

3.2 RELATIVE LOSS FACTOR, $\tan \delta / \mu_i$

Addition of an air gap to a magnetic circuit changes the values of its loss factor and effective permeability. The amounts of change are nearly proportional to each other, so that the loss factor per unit effective permeability may be used as a coefficient which, as defined as $\tan \delta / \mu_i$, indicates a characteristic of the magnetic material.

$$\tan \delta / \mu_i = \frac{1}{\mu_i} (e_1 f + c_1)$$

It follows therefore that the loss factor for a practical core can be expressed in the following formula:

$$(\tan \delta)_c = \tan \delta / \mu_i \times \mu_e$$

Where $(\tan \delta)_c$ represents the particular loss factor.

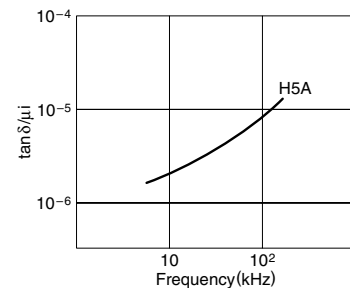

Fig. 4

3.3 RELATIVE HYSTERESIS LOSS COEFFICIENT, h_{10} *

When an air gap is introduced into a magnetic circuit, its hysteresis loss coefficient, h_1 , changes approximately as $3/2$ power of the effective permeability. On the basis of this fact, relative hysteresis loss coefficient, h_{10} , is defined as the value of this loss h_1 corrected to the condition of $\mu_i + 1000$. The value of h_{10} for different magnetic materials can be compared for comparative evaluation of the materials. For this purpose, the relative hysteresis loss coefficient is determined for and assigned to each material.

$$h_{10} = h_1 \cdot \left(\frac{1000}{\mu_i} \right)^{3/2}$$

Thus, the hysteresis loss coefficient, $\tan \delta_h$, for a practical core is expressed by the following formula:

$$\tan \delta_h = h_{10} \cdot \left(\frac{\mu_i}{1000} \right)^{3/2} \cdot \sqrt{\frac{L}{V}} \cdot i \quad \text{Note* : } h_{10} \text{ is read "h one-zero."}$$

The relationship between η_B and other constants are as follows:

$$\begin{aligned} \eta_B &= 19.9 h_{10} \times 10^{-6} \\ \eta_B &= 1.12 \times h' / \mu^2 \\ \eta_B &= 896 \times h / \mu^2 \\ h_{10} &= 50.3 \eta_B \times 10^3 \end{aligned}$$

where, η_B = hysteresis material constant in IEC

$$\frac{h'}{\mu^2} = \text{hysteresis constant in DIN}$$

$$\frac{h}{\mu^2} = \text{hysteresis constant in Jordan}$$

3.4 QUALITY FACTOR, Q

Quality factor is defined as the reciprocal of the loss coefficient, as follows:

$$Q = \frac{1}{\tan \delta} = \frac{\omega L}{R_m}$$

3.5 EFFECTIVE QUALITY FACTOR, Q_e

The effective quality factor refers to the loss coefficient of a coil complete with a ferrite core, and is the reciprocal of that coefficient:

$$Q_e = \frac{\omega L}{R_{\text{eff}}}$$

Where R_{eff} is the effective loss resistance of the coil.

3.6 APPARENT QUALITY FACTOR, Q_{app}

This factor is the ratio of the two values of effective quality factor measured on a test coil, one (Q_e) is coil with core, and the other (Q_0) is coil without core.

$$Q_{\text{app}} = \frac{Q_e}{Q_0}$$

where, Q_e = coil with core

Q_0 = coil without core

4. TEMPERATURE CHARACTERISTICS

4.1 TEMPERATURE COEFFICIENT OF INITIAL PERMEABILITY, $\alpha_{\mu i}$

This temperature coefficient is defined as the change of initial permeability per degree C over a prescribed temperature range. This change is expressed in terms of fraction of the original value of initial permeability. It is determined by the following formula:

$$\alpha_{\mu i} = \frac{\mu_{i2} - \mu_{i1}}{\mu_{i1}} \cdot \frac{1}{T_2 - T_1}$$

where, μ_{i1} = initial permeability at temperature T_1

μ_{i2} = initial permeability at temperature T_2

The value of T_1 is normally taken at 20°C. The coefficient is expressed in units of 10^{-6} .

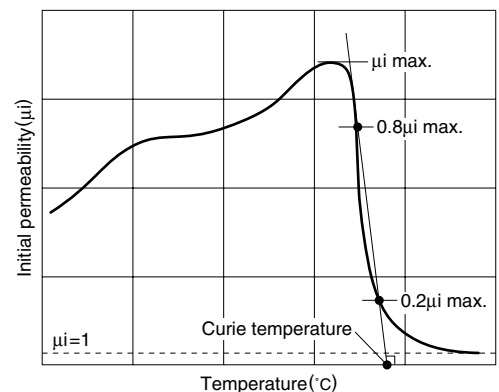

Fig. 5

4.2 TEMPERATURE FACTOR OF INITIAL PERMEABILITY, α_F

The change of temperature coefficient, α_μ , due to an air gap added to a magnetic circuit is nearly proportional to the change of effective permeability. On the basis of this fact, temperature factor of permeability, α_F , is defined as the value of temperature coefficient, α_μ , per unit permeability, and is determined by the following formula:

$$\alpha_F = \frac{\alpha_\mu}{\mu_i} = \frac{\mu_{i2} - \mu_{i1}}{\mu_{i1}^2} \cdot \frac{1}{T_2 - T_1}$$

The value so determined is assigned to each material as its characteristic. For the temperature coefficient of a practical core, the following formula is used.

$$\alpha_\mu = \alpha_F \times \mu_e$$

4.3 CURIE TEMPERATURE T_c

The critical temperature at which a core transfers from ferromagnetism to paramagnetism.

Note: There are many ways to determine the Curie temperature. At TDK, however, it is determined as shown in Fig.5.

5. PHENOMENON OF GRADUAL DECREASE IN PERMEABILITY

5.1 SPONTANEOUS DECREASE OF PERMEABILITY

In ferrite cores, the permeability begins to decrease upon formation by sintering and continues to decrease with the lapse of time. This property is referred to as the spontaneous decrease of permeability.

In general, the rate of spontaneous permeability decrease is approximately linear when it is related to the logarithm of time ($\log t$) and, therefore, becomes negligibly small in about a month's time after sintering. The magnitude of this decrease in terms of μ_e/μ_i can be reduced substantially with increasing air gap.

5.2 DISACCOMMODATION, D

Disaccommodation, as will be noted in the following formula which determines its value: The time rate of initial permeability changes at normal temperature in a core that has just been AC demagnetized, where the core is kept free from mechanical or thermal stress of any kind.

$$D = \frac{\mu_1 - \mu_2}{\mu_1} \times 100(\%)$$

where, μ_1 = initial permeability noted immediately after the material is AC demagnetized.

μ_2 = initial permeability noted some time after the material is AC demagnetized.

Disaccommodation and spontaneous decrease are two distinct concepts but some correlation is noted to exist between the two. The disaccommodation of a material is considered suggestive of its property of spontaneous decrease and also the permeability change that the material would exhibit when subjected to mechanical or magnetic shocks.

5.3 DISACCOMMODATION FACTOR, D_F

For cores with air gap, the disaccommodation of the material in the circuit is nearly proportional to its effective permeability. The value of disaccommodation per unit permeability is designated as the disaccommodation factor (D_F)-one of the characteristics-and is determined for each material.

$$D_F = \frac{\mu_1 - \mu_2}{\log_{10} \frac{t_2}{t_1}} \cdot \frac{1}{\mu_1^2} (t_2 > t_1)$$

where, μ_1 = initial permeability noted at time t_1 after the material is AC demagnetized.

μ_2 = initial permeability noted at time t_2 after the material is AC demagnetized.

Normally t_1 , is 1 minute, and t_2 is 10 minutes; but up to 10 and 100 minutes, respectively, are occasionally used.

For a practical magnetic core, the following formula is used to determine its disaccommodation:

$$D = D_F \times \mu_e$$

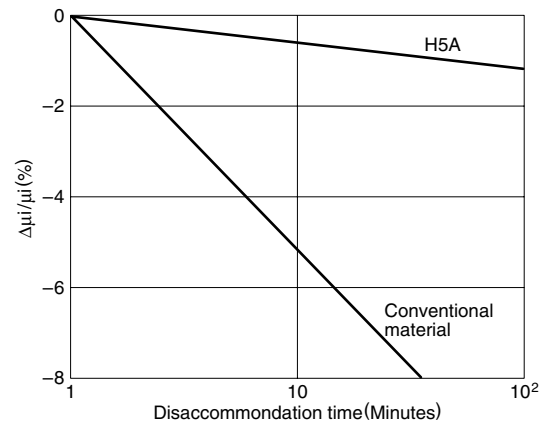

Fig. 6

6. INDUCTANCE COEFFICIENT, A_L

Inductance coefficient is defined as the self-inductance per unit turn of a coil of a given shape and dimensions wound on a magnetic core, and is determined by the following formula:

$$A_L = \frac{L}{N^2}$$

where, L = self-inductance of coil with core(H)

N = number of turns

This coefficient is normally expressed in units of $10^{-9}\text{H}(1\text{nH})$.
Shapes and dimensions are separately prescribed for test coils to be used in the measurement for A_L .

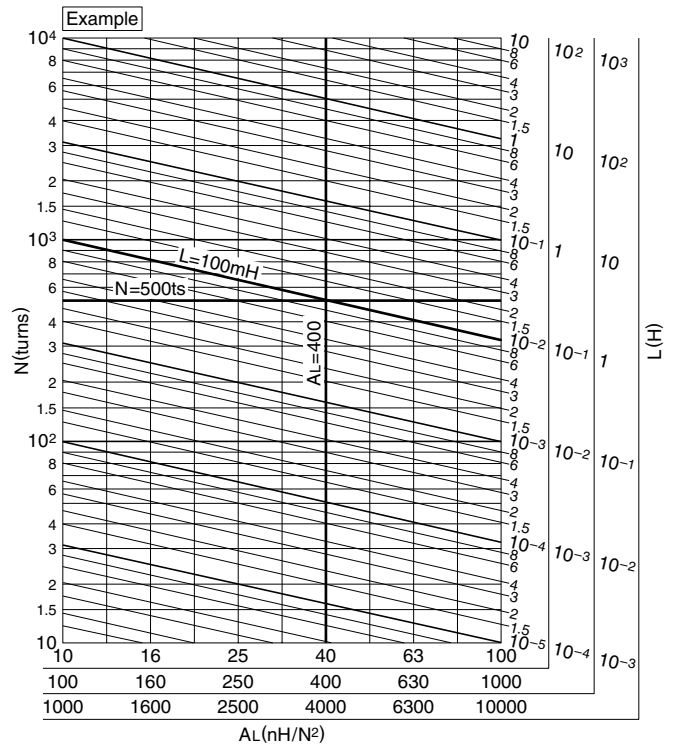

7. WINDING COEFFICIENT, α

Winding coefficient is defined as the number of coil turns required for producing unit self-inductance in a coil of a given shape and dimensions wound on a core, and is determined by the following formula:

$$\alpha = \frac{N}{\sqrt{L}}$$

where, L = self-inductance of coil with core(H)

N = number of turns

Normally 1mH is taken for the L in this case.

8. ELECTRICAL RESISTIVITY, ρ_v

Electrical resistivity is the resistance measured by means of direct voltage of a body of ferromagnetic material having a constant cross-sectional area.

9. DENSITY, d_b

Specific gravity of a magnetic core is calculated from its volume and mass, as shown in below.

$$d_b = W/V(\text{kg/m}^3)$$

where, W = mass of the magnetic core

V = volume of the magnetic core

Note: The symbol and the catalog of this data are in accordance with IEC Publication 60401-3.

MATERIAL CHARACTERISTICS

For Telecommunication

Material				H5A	H5B2	H5C2	H5C3	H5C4		
Initial permeability	μ_i				3300 ^{+40%} _{-0%}	7500±25%	10000±30%	15000±30%	12000±30% ≥ 9000(-20°C)	
Relative loss factor	$\tan\delta/\mu_i$	$\times 10^{-6}$				<2.5(10kHz) <10(100kHz)	<6.5(10kHz)	<7.0(10kHz)	<7.0(10kHz)	<8(10kHz)
Temperature factor of initial permeability	$\alpha_{\mu ir}$	$\times 10^{-6}$	-30 to +20°C	-0.5 to 2.0	0 to 1.8	-0.5 to 1.5	-0.5 to 1.5	-0.5 to 1.5	-0.5 to 1.5	
			0 to 20°C	-0.5 to 2.0	0 to 1.8	-0.5 to 1.5	-0.5 to 1.5	-0.5 to 1.5	-0.5 to 1.5	
Saturation magnetic flux density* [H=1194A/m]	Bs	mT	25°C	410	420	400	360	380		
Remanent flux density*	Br	mT	25°C	100	40	90	105	100		
Coercive force*	Hc	A/m	25°C	8.0	5.6	7.2	4.4	4.4		
Curie temperature	Tc	°C		>130	>130	>120	>105	>110		
Hysteresis material constant	τ_B	$\frac{10^{-6}}{mT}$		<0.8	<1.0	<1.4	<0.5	<2.8		
Disaccommodation factor	D _F	$\times 10^{-6}$		<3	<3	<2	<2	<3		
Density*	db	kg/m ³		4.8×10 ³	4.9×10 ³	4.9×10 ³	4.95×10 ³	4.95×10 ³		
Electrical resistivity*	ρ_V	$\Omega \cdot m$		1	0.1	0.15	0.15	0.15		

Material				H5C5	HP5	DNW45	DN40	DN70	
Initial permeability	μ_i				30000±30%	5000±20%	4200±25%	4000±25%	7500±25%
Relative loss factor	$\tan\delta/\mu_i$	$\times 10^{-6}$	25°C, 10kHz	<15	<3.5	<3.5	<2.5	<2.0	
Temperature factor of initial permeability	$\alpha_{\mu ir}$	$\times 10^{-6}$	-30 to +20°C	-0.5 to 1.5			-0.5 to 2.0	-0.5 to 1.5	
			0 to 20°C		±12.5%				
20 to 70°C	-0.5 to 1.5	±12.5%			-0.5 to 2.0	-0.5 to 1.5			
Saturation magnetic flux density* [H=1194A/m]	Bs	mT	25°C	380	400	450	405	390	
Remanent flux density*	Br	mT	25°C	120	65	50	95	45	
Coercive force*	Hc	A/m	25°C	4.2	7.2	6.5	8.0	3.5	
Curie temperature	Tc	°C		>110	>140	>150	>130	>105	
Hysteresis material constant	τ_B	$\frac{10^{-6}}{mT}$		<1.5	<0.4	<0.8	<0.8	<0.2	
Disaccommodation factor	D _F	$\times 10^{-6}$		<2	<3	<3	<3	<2.5	
Density*	db	kg/m ³		4.95×10 ³	4.8×10 ³	4.85×10 ³	4.8×10 ³	5.0×10 ³	
Electrical resistivity*	ρ_V	$\Omega \cdot m$		0.15	0.15	0.65	1.0	0.3	

* Average value

For Transformer and Choke

Material				PC40	PC44	PC47	PC50	
Initial permeability	μ			2300±25%	2400±25%	2500±25%	1400±25%	
Amplitude permeability	μ_a			3000 min.	3000 min.			
Core loss volume density (Core loss)* [B=200mT]	Pcv	kW/m ³	25kHz sine wave	25°C			120	
				60°C			80	
				100°C			70	
				120°C			85	
			100kHz sine wave	25°C	600	600	600	130**
				60°C	450	400	400	80**
				100°C	410	300	250	80**
				120°C	500	380	360	110**
Saturation magnetic flux density* [H=1194A/m]	Bs	mT	25°C	510	510	530	470	
			60°C	450	450	480	440	
			100°C	390	390	420	380	
			120°C	350	350	390	350	
Remanent flux density*	Br	mT	25°C	95	110	180	140	
			60°C	65	70	100	110	
			100°C	55	60	60	98	
			120°C	50	55	60	100	
Coercive force	Hc	A/m	25°C	14.3	13	13	36.5	
			60°C	10.3	9	9	31.0	
			100°C	8.8	6.5	6	27.2	
			120°C	8	6	7	26.0	
Curie temperature*	Tc	°C		>215	>215	>230	>240	
Density*	db	kg/m ³		4.8×10 ³	4.8×10 ³	4.9×10 ³	4.8×10 ³	
Electrical resistivity*	ρ_v	$\Omega \cdot m$		6.5	6.5	4.0	30	

Material				PC45	PC46	PC33	PC95	
Initial permeability	μ			2500±25%	3200±25%	1400±25%	3300±25%	
Amplitude permeability	μ_a							
Core loss volume density (Core loss)* [B=200mT]	Pcv	kW/m ³	100kHz sine wave	25°C	570	350	1100	350
				60°C	250(75°C)	250(45°C)	800	
				100°C	460	660	600	290
				120°C	650	760	680	350
Saturation magnetic flux density* [H=1194A/m]	Bs	mT	25°C	530	520	510	530	
			60°C	480	470	490	480	
			100°C	420	410	440	410	
			120°C	390	380	420	380	
Remanent flux density*	Br	mT	25°C	120	80	220	85	
			60°C	80	80	150	70	
			100°C	80	130	100	60	
			120°C	110	140	100	55	
Coercive force*	Hc	A/m	25°C	12	10	23	9.5	
			60°C	9	9	17	7.5	
			100°C	8	10	14	6.5	
			120°C	9	9	14	6.0	
Curie temperature	Tc	°C		>230	>230	>290	>215	
Density*	db	kg/m ³		4.8×10 ³	4.8×10 ³	4.8×10 ³	4.9×10 ³	
Electrical resistivity*	ρ_v	$\Omega \cdot m$		3.0	3.0	2.5	6.0	

* Average value

** 500kHz, 50mT

For Common mode Choke

Material				HS52	HS72	HS10
Initial permeability	μ			5500±25%	7500±25% (2000min. at 500kHz)	10000±25%
Relative loss factor	$\tan\delta/\mu$	$\times 10^{-6}$		10(100kHz)	30(100kHz)	30(100kHz)
Saturation magnetic flux density* [H=1194A/m]	Bs	mT	25°C	410	410	380
Remanent flux density*	Br	mT	25°C	70	80	120
Coercive force*	Hc	A/m	25°C	6	6	5
Curie temperature	Tc	°C		>130	>130	>120
Density*	db	kg/m ³		4.9×10 ³	4.9×10 ³	4.9×10 ³
Electrical resistivity*	ρ_v	$\Omega \cdot m$		1	0.2	0.2

* Average value

• All specifications are subject to change without notice.

INITIAL PERMEABILITY, μ_i vs. FREQUENCY CHARACTERISTICS
Mn-Zn FERRITE

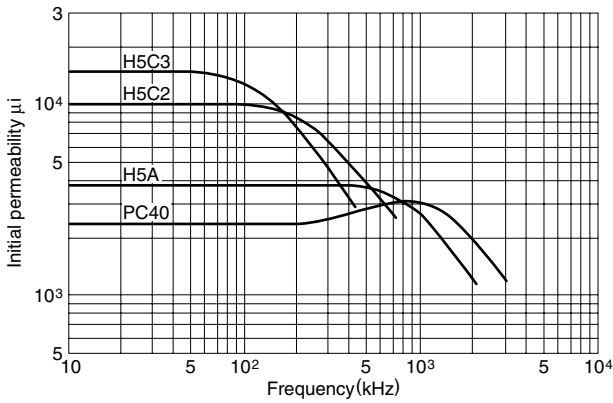

RELATIVE LOSS FACTOR, $\tan\delta/\mu_i$ vs. FREQUENCY CHARACTERISTICS
Mn-Zn FERRITE

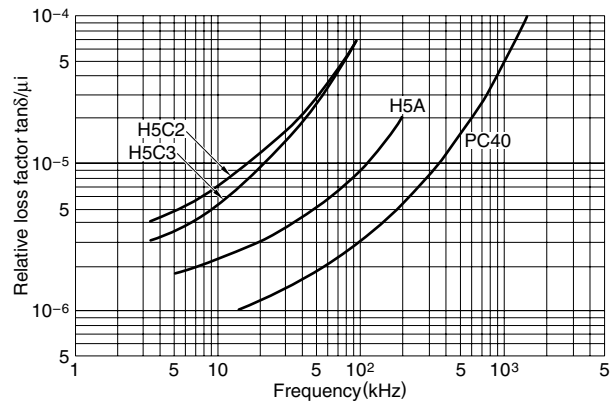

FERRITE FOR PULSE TRANSFORMERS

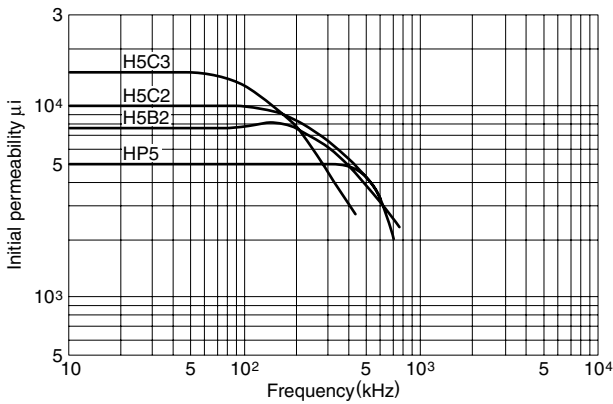

FERRITE FOR PULSE TRANSFORMERS

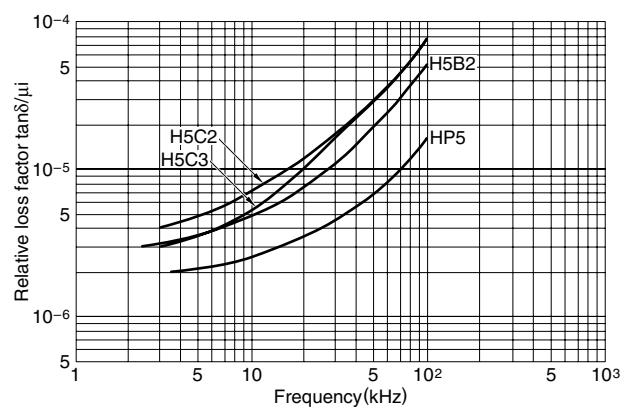

INITIAL PERMEABILITY, μ_i , RELATIVE LOSS FACTOR, $\tan\delta/\mu_i$ vs. TEMPERATURE CHARACTERISTICS
H5A

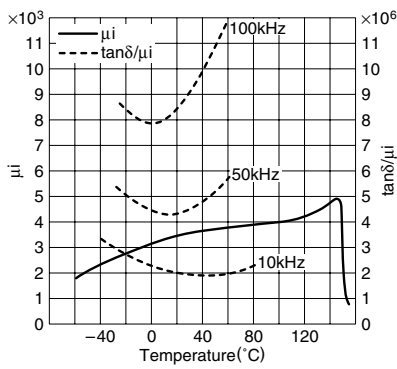

• All specifications are subject to change without notice.

INITIAL PERMEABILITY, μ_i vs. TEMPERATURE CHARACTERISTICS

H5B2

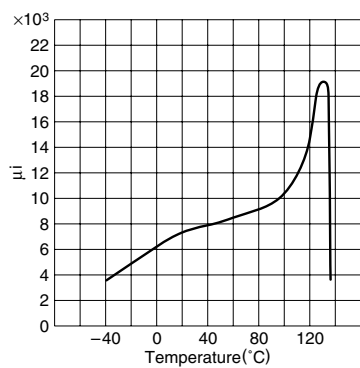

H5C2

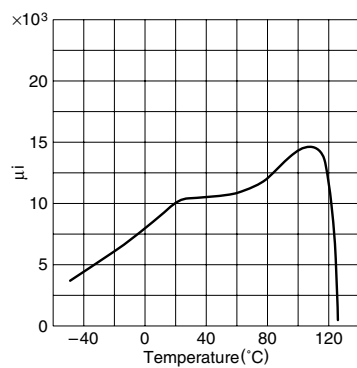

H5C3

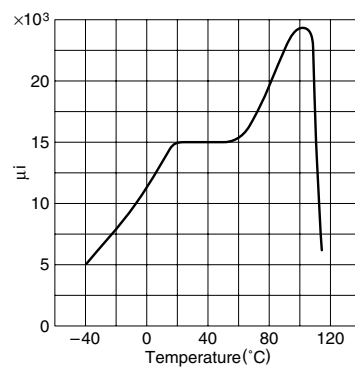

HP5

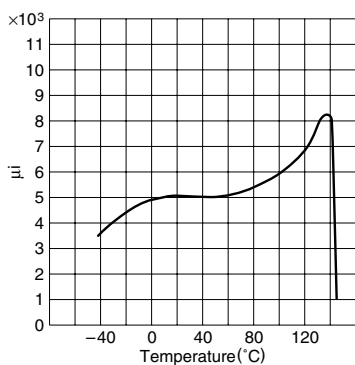

PC40

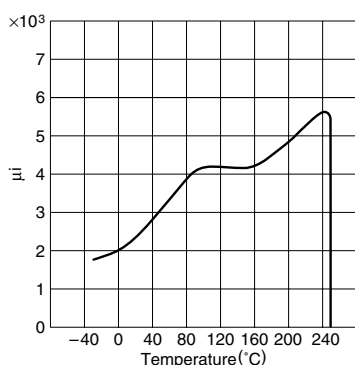

PC44

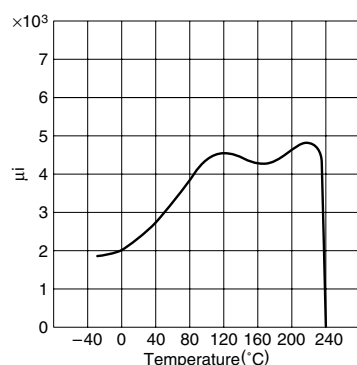

PC50

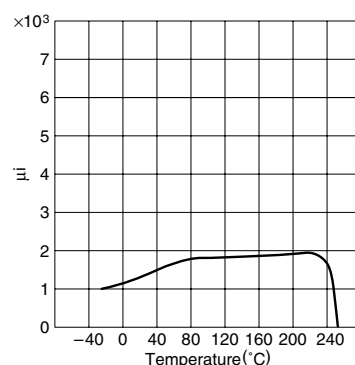

PC47

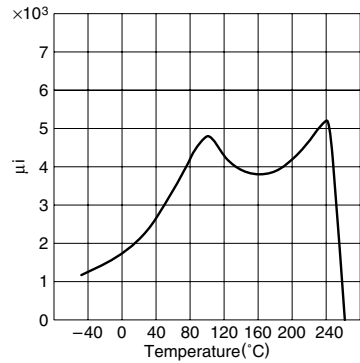

PC45

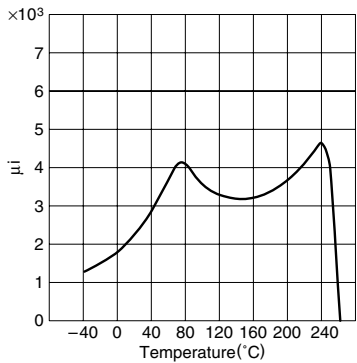

PC46

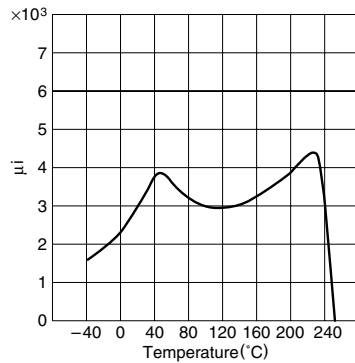

• All specifications are subject to change without notice.

INITIAL PERMEABILITY, μ_i vs. TEMPERATURE CHARACTERISTICS

PC95

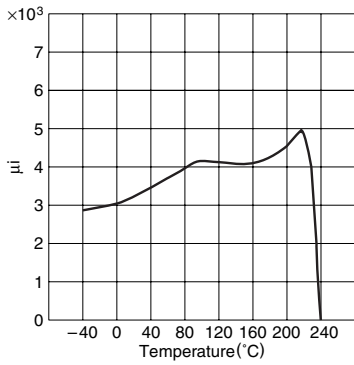

STATIC MAGNETIZATION CURVES

H5A

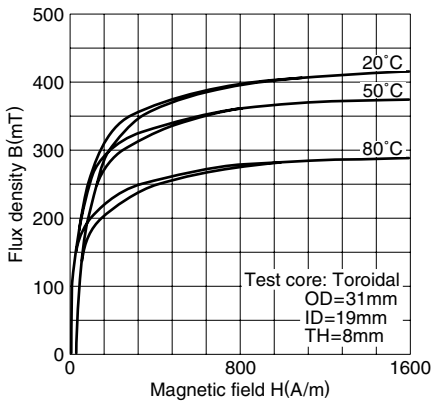

H5B2

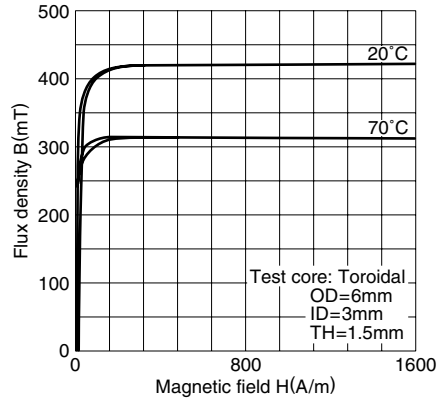

H5C2

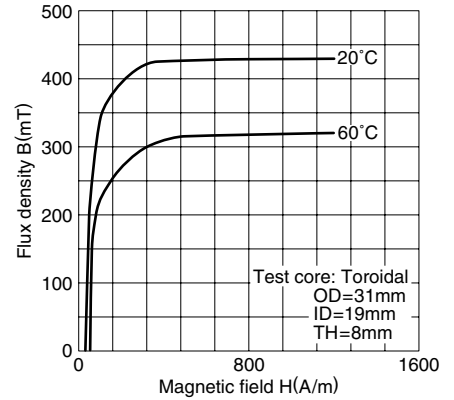

H5C3

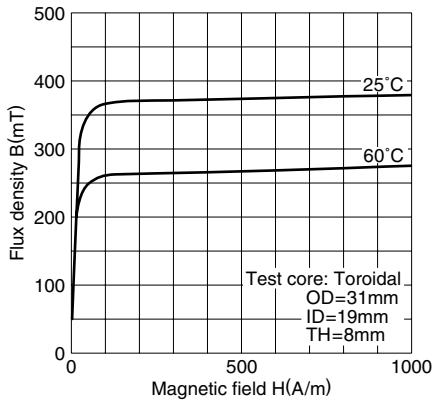

HP5

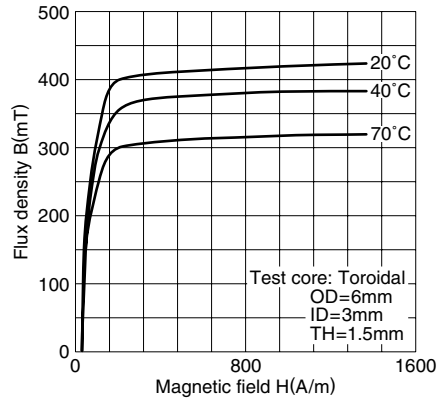

PC40

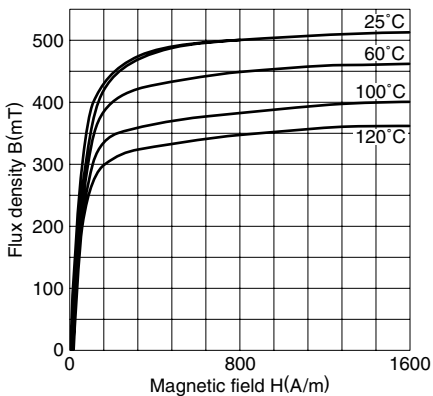

PC44

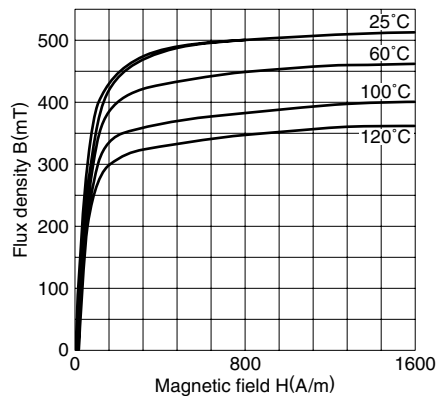

PC50

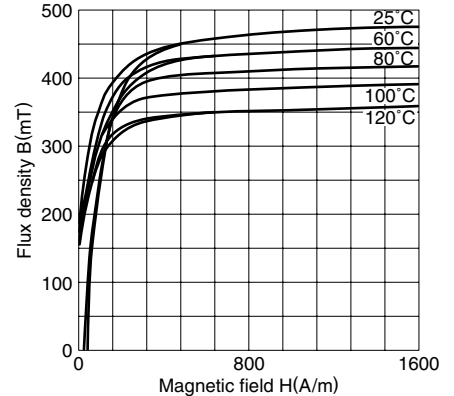

Note: The static magnetization curves were obtained by TYPE 3257 Hysteresis-Loop-tracer.

STATIC MAGNETIZATION CURVES

PC45

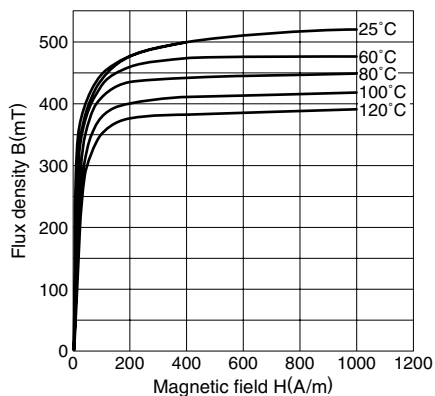

PC46

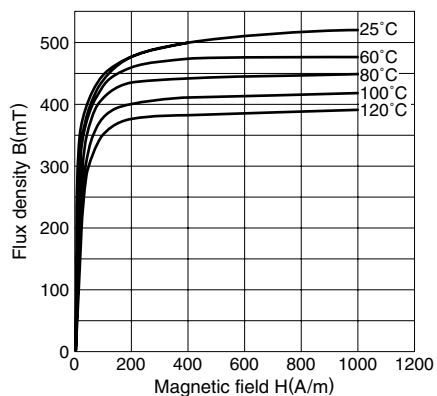

PC47

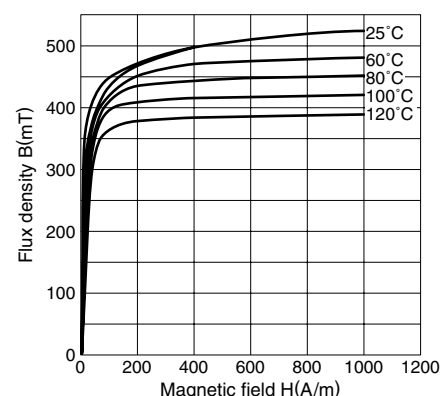

PC95

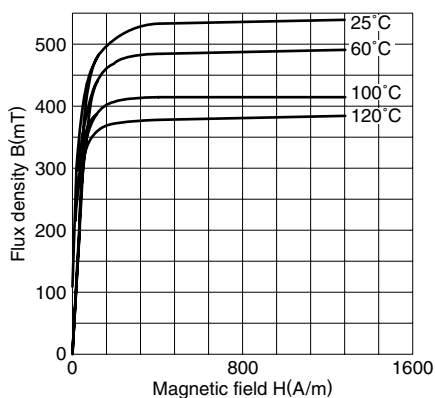

• All specifications are subject to change without notice.

APPLICATION EXAMPLES OF TDK'S FERRITE CORES

Application examples		Features	Material name	Core shape
Carrier (transmission) circuit	Conversion filter for frequency division multiplex system	Low loss	H5A	T(Toroidal)
	Input/output transformers for repeater	High stability	H5C2	EP
	For multifrequency code signal oscillator of touch-tone telephone		H5C3	EPC
	Various modulator/demodulator circuits		HS72	EE
	Matching transformers for filter		PC40	EER
	Matching transformers for various signal circuit		PC44	EC
			PC50	P(Pot)
Data transmission circuit	Hybrid transformers for FDM	High permeability	HP5	T(Toroidal)
	Pulse transformers for PCM	Wideband and low loss	H5B2	EP
	Input/output transformers of memory unit	High stability	H5A	EE
	Pulse transformers for electronic switching system	High saturation magnetic flux density	H5C2	EPC
	Input/output transformers for repeater		H5C3	P(Pot)
			PC40	RM
			PC44	EER
			PC50	EC
Power supply circuit	High output transformers	High saturation magnetic flux density	H5A	T(Toroidal)
	High voltage transformers	High permeability	H5C2	EP
	Main transformers for switching regulator	Low loss	H5C3	EPC
	Smoothing choke coils for switching regulator	Low temperature rise	HS72	EE
	Power transformers for inverter		PC40	EER
	Power transformers for converter		PC44	EC
	Step-up transformers		PC50	P(Pot)
	Saturable reactors			
For EMC countermeasure	Common mode choke coils for power circuit	High permeability	HS72	T(Toroidal)
	Common mode choke coils for signal line	High saturation magnetic flux density	HS52	EE
	Line choke coils		HS10	Rod type
	Beads for prevention of parasitic oscillation		HP5	Cylindrical type
	For electromagnetic shield		H5A	ET
	For EMI filters		H5B2	UU
			H5C2	FT
			H5C3	
Examples of application circuit and equipment	Filters for railway signal	High permeability	H5A	P(Pot)
	Medical equipment	High stability	H5C2	Miniature pot
	Measuring and testing equipment	High saturation magnetic flux density	PC40	EE
	Magnetic sensors		Others	EI
	Road traffic control systems			EER
	Coils and transformers for watch			EC
	Transformers and coils for acoustic sounder			Rod type
Acoustic equipment networks			C(Cup) type	
			Square type	
			Disc type	
			Cylindrical type	

PRECAUTIONS

1. INTRODUCTION

1.1 CORES WITHOUT AIR GAP

TDK manufactures various ferrite core shapes, such as Pot cores, RM cores, E cores, EP cores, etc. There is a broad selection of materials, so optimum combinations of high permeability, high flux density and low losses can be chosen. Therefore, the user can specify the combination of shape and material for use in inductors, transformers, and many other applications.

TDK is able to process cores with very smooth, mirror-like contact surfaces. Such exacting smoothness enables the initially-high core permeability to be retained after core assembly. Therefore, such high-polished cores are the optimum choice for precision and minimum-sized coils.

When cores are employed without air gaps, remove any outer particles(contamination, grease, etc.) from the contacting surfaces prior to assembly. It is recommended that the contacting surfaces be rubbed against each other several times in order to make intimate contact. This will assure that the highest effective permeability is obtained.

1.2 CORES WITH AIR GAP

TDK provides ferrite cores with a preset, machined, air gap. Such cores are ideal for precision inductors. Gapped cores permit minimum inductor tolerances, and provide best stability during temperature variations or aging. The gap size is determined by the required AL-value. Users need to specify only the AL-value. TDK will automatically select the required gap dimension.

If the gap is large, then the gap is evenly distributed on both sides of the core. However, if the gap size is less than 0.4mm approx., then the gap machined on only one of the core pair. In the case of small gaps, the gapped core is marked to differentiate between the gapped and ungapped parts.

1.3 EFFECTIVE PARAMETER FOR CORES

In this catalog, the effective parameters related to the magnetic circuits of cores are shown on the page on which the core dimension is mentioned. These parameters are used for calculating the measured value of effective permeability, flux density and magnetic field intensity of the cores.

Core factor $\Sigma l/A = C_1$ (mm⁻¹)

Effective cross-sectional area A_e (mm²)

Effective magnetic path length l_e (mm)

Effective volume V_e (mm³)

The formulas for calculating these four parameters are stated in "IEC Publication 205", and the calculated values shown in this catalog are also based on them. These values are calculated on the assumption that the path of magnetic flux is an ideal magnetic path, and do not always coincide with the purely geometrical calculation. Especially, as when the magnetic flux density in the uneven and complex shaped cores is examined, the use of the minimum cross-sectional area geometrically calculated may be more practical.

2. DESIGN CONSIDERATION

2.1 RELATIONSHIP BETWEEN WINDING SPACE USED AND INDUCTANCE

The Fig.1 shows the dependence of inductance with regards to the actual height of the winding. Inductance increases as winding height increases. This effect is particularly prominent for cores with large air gap(i.e. low AL-value). The AL-value therefore is a value to be determined and guaranteed under specified winding conditions.

RELATIONSHIP BETWEEN WINDING SPACE USED AND INDUCTANCE

H5AP22/13-52H

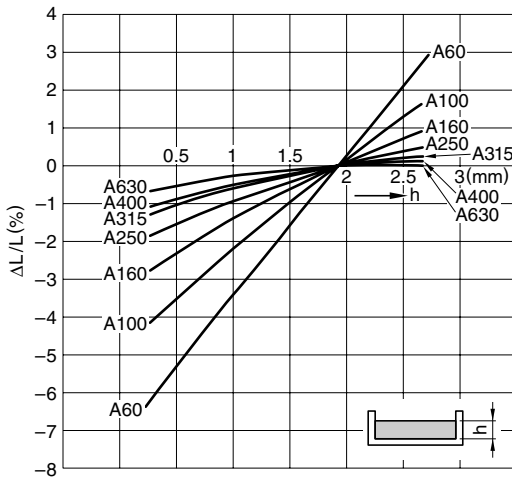

H5AP26/16-52H

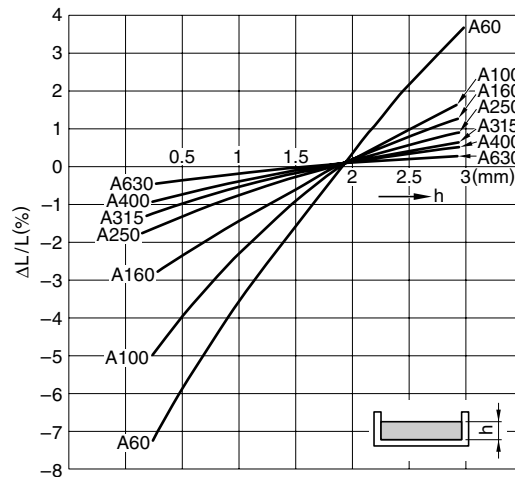

Fig. 1

2.2 EFFECTS OF DISTRIBUTED CAPACITY ON INDUCTANCE

Any coils have also a capacitive effect, called distributed capacity, because of closeness of the windings. This capacitive effect is particularly harmful for coils with several hundred to several thousand turns and the result is that a significant deviation from the calculated inductance may occur.

The distributed capacity and its influence can be reduced by the following methods:

- Separate the first layer of winding from the last(outermost) layer as much as possible; for instance, by insulation tape.
- Use a bobbin with multiple sections.
- Connect the beginning of winding with the low potential(ground) in the circuit.

2.3 STABILITY OF INDUCTANCE

Design of stability

For a highly reliable filter used in communications equipment, stability extending for a long period of time is required, such as ten years, twenty years, etc. The three items to be considered in designing coils for filters are as follows:

- Disaccommodation factor of the ferrite core
- Temperature coefficient of the ferrite core
- Safety margin for assembling the coil

As for item(a), coils can be designed by a method described in the following paragraph by determining the core shape, material and AL-value.

As for item(b), the values are specified in this catalog according to the core sizes, material and AL-value. These values should be used.

As for item(c), such a safety margin is a constant based on the experience of users who actually carry out assembly operation of coils.

Calculation of aging

One general characteristic of ferrite cores is that their permeability starts to decline with the passing of time immediately after sintering. The factor indicating the rate of this aging is known as the “disaccommodation factor D_F ” and this factor is described on the “Terms Definitions and Explanations” in the explanatory part of this catalog. Each material used for the ferrite core gives the disaccommodation factor of its own. The resulting factors are given in the material characteristics table.

When designing inductance elements to a precision of estimating the amount of change in the inductance in ten years’ or twenty years’ time, the disaccommodation factor can be used to gauge in advance just how much this inductance will vary. The changes in the permeability, or in other words the inductance, vary almost linearly with respect to the logarithm of the time involved. This can be expressed in the following formula using the disaccommodation factor D_F .

$$\frac{\Delta L}{L} = D_F \times \mu_e \log_{10} \frac{t_2}{t_1} \quad (t_2 > t_1)$$

where, $\Delta L/L$ = the variation rate of the inductance from t_1 to t_2

D_F = the disaccommodation factor

μ_e = the effective permeability(permeability “ μ ” is used for closed magnetic circuits without joins such as ring-shaped cores.)

t_1 = the initial time(the point in time when the core is manufactured is set as the starting point.)

t_2 = the targeted end time(the point in time when the core is manufactured is set as the starting point.)

Calculation example:

Material: H5A

$D_F = 3 \times 10^{-6}$ maximum(according to the material characteristics table)

Effective permeability= 200

t_1 = coil assembly in the second month after the manufacture of core

t_2 = twenty years later($12 \times 20 = 240$ months)

with the above conditions, the variation rate of the inductance in twenty years’ time will be as follows:

$$\begin{aligned} \Delta L/L &= 3 \times 10^{-6} \times 200 \times \log_{10} \frac{240}{2} \\ &= 1247.5 \times 10^{-6} \\ &= 0.125\% \end{aligned}$$

In other words, the inductance will decline 0.125% in twenty years’ time.

Note: The same kind of phenomenon occurs as soon as, for instance, a core is exposed to a temperature exceeding the Curie temperature, exposed to a strong magnetic shock whereby the saturation magnetic flux density is reached, or as soon as a core is affected by violent stress.

If the above incidents are taken as the starting point of the decline in inductance t_1 and t_2 are then set, it is then possible, as in the above example, to predict how much the inductance will vary.

Apart from the extreme instances given above, there are other variations caused by various shocks incurred in general handling of the core. These, however, are minimal with cores a few months after their manufacture and they do not therefore pose any problems.

2.4 DC PRE-MAGNETIZATION CHARACTERISTICS

H5A P30/19

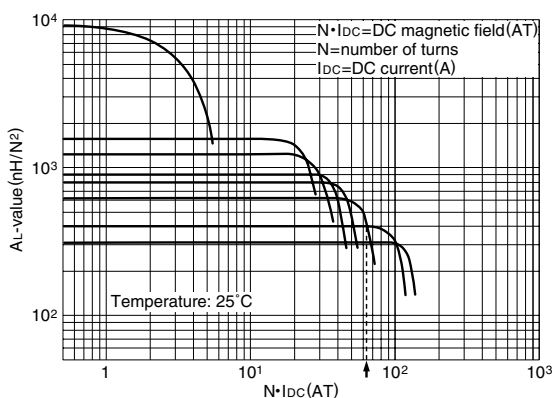

Fig. 2

Fig.2 shows the characteristics in terms of changes of the AL-value with respect to the DC magnetic field. When designing a transformer using an EE or Pot core, these are the characteristics which are required for ascertaining the limits of stable use without causing any changes in inductance with respect to the DC pre-magnetization.

Usually in the design of transformers which pre-magnetize the DC an air gap is provided in the magnetic circuit of the core and this is used with the A_L -value(nH/N²) which is necessary. The standard A_L specifications are listed under the items for the EE and Pot cores.

Example:

Pot core: H5AP30/19A400-52H

Material: H5A

A_L -value: 400(nH/N²)

The limit by which the permeability does not drop due to the DC magnetic field is $NI=65AT$ (indicated by an arrow in the Fig.2) on the figure illustrating the DC pre-magnetization characteristics of the P30/19 core of material H5A .

Therefore, with a single turn, a transformer can be used stably up to 65A.

2.5 CALCULATION OF FLUX DENSITY

In the graphs of the B-H curve and the power loss used this catalog, flux density is used as parameter. Also there are many convenient cases in which the level applied to the core is expressed by use of flux density. In case of sine wave, this flux density can be obtained from the following formulas:

$$\hat{B} = \frac{E}{\sqrt{2\pi \cdot f \cdot N \cdot A_e}} \times 10^9 (\text{mT})$$

where, V = voltage applied to coil(Vrms)

f = frequency(Hz)

N = number of turns (turns)

A_e = effective area (mm²)

\hat{B} = peak value of flux density

3. PRECAUTIONS FOR COIL ASSEMBLY TO OBTAIN A STABLE COIL

There should be no contamination or grease on mating surface as these become obstacles in obtaining the inductance desired. These also can be cause of instability. Either on outside or inside of the core, should there not be contamination or grease since these can make gluing of cores and/or accessories difficult.

When gluing coilformer to the core, adhesive materials and the point to glue should be carefully selected, and the quantity of the adhesive should also be limited to the minimum necessary, because the thermal expansion coefficient is very different between ferrite cores and adhesive materials, thus causing mechanical stress which gives undesirable effects on electrical performance.

3.1 ADHESIVE AND ITS PREPARATION

The following adhesives are recommended depending on the parts to be glued.

3.1.1 For coilformer

Adhesive: Synthetic rubber adhesive(Example: Sony Bond, SC12N)

This adhesive gets cured in about 12 hours at room temperature. If the coil must be sealed within a case, it is advised that the coil be put outside about 24 hours after usage of the adhesive so organic solvents contained in the adhesive be sufficiently volatilized.

Note: Synthetic rubber adhesive is the adhesive made Chloroprene Rubber dissolved by organic solvents. This kind of adhesive is usually dried after spreading to such extent as fingers do not get too sticky so this glues well. If not dried enough, adhesive spreads too wide when pressed tight which is undesirable.

3.1.2 For cores

Adhesive: Mixture of Araldite AW106(100 grams) and Hardener HV953U(80 grams)

Pot life: About 2 hours(at 20°C)

At room temperature, curing time of about 12 hours is necessary. To expedite curing, it is advisable to cure at 70°C for 2 hours approximately.

Note: Mix Araldite AW106 and Hardener HV953U at the weight ratio, 5:4. As the pot life of this adhesive is about 2 hours, this mixing should be done only to the minimum quantity necessary.

3.2 ASSEMBLING

3.2.1 Preparation

Remove contamination from inside and outside of the core using a dry brush. Grease on the mating surfaces of the core should be wiped away. For this purpose, a stamp pad soaked in alcohol or other organic solvents is recommended, but the surface of this stamp pad should be with a non-fluffy nylon coated cloth. The usage of the dry second stamp pad to remove moisture may be useful.

3.2.2 Assembling of coilformer

Apply a dot of adhesive per Clause 3.1.1 onto the inside bottom of the core and insert the coilformer to glue as Fig.3(refer to Note 1).

It is not desirable to spread adhesive all over the bottom surface. Leave the glued parts 12 hours approximately at room temperature so the adhesive cures completely. Then, put the core into the mounting assemblies, rotate core halves against each other 2 or 3 times, and match the core halves to the center using a jig or visually(refer to Note 2).

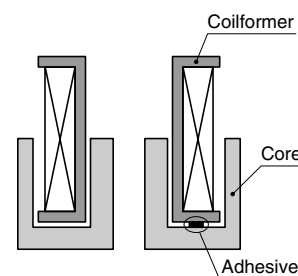

Fig. 3

Note 1: The reason why the adhesive is applied in one dot only is that difference of thermal expansion coefficient causes mechanical stress inside the ferrite core, thus affecting various characteristics especially Temperature Coefficient of coil.

Note 2: The jig is not available from us, but its drawings are available upon your request.

3.2.3 Gluing of cores

To glue the core set fitted inside the mounting assemblies, it is advisable to be aligned the cores properly and to glue the two points on the outside of the cores as Fig.4.

Gluing the core with the mounting assemblies is not preferable and so should be avoided. Here, epoxy adhesive per Clause 3.1.2 is recommended.

In case mounting assemblies are not used, outer circumferential matting surface(ring) can be glued as Fig.5. In this case, the core halves should be rotated to each other several times, so that adhesive spreads all over the matting surfaces as thin as possible.

Then the core halves should be matted and kept under pressure of 0.2N/mm² until the adhesive cures. Slug of the core should not be glued.

For curing this glued core, approximately 12 hours at room temperature is necessary. To expedite curing, it is advised to put the core into the oven and heat at 70°C for 2 hours approximately.

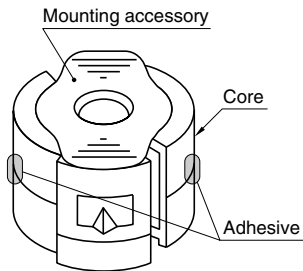

Fig. 4

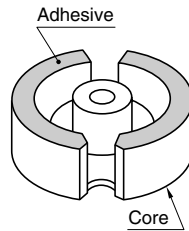

Fig. 5

3.3 IMPREGNATION OF COIL

In case there is a demand to minimize effect of humidity, vacuum impregnation by wax should be done only on coilformer and not on the core. A good electrical quality wax herewith should be used and the temperature during impregnation should be kept below the maximum allowable temperature of the coilformer.

When inserting the coilformer, care should be taken that wax does not stick onto the matting surfaces of the core.

In case higher electrical stability is required, hermetic sealing is recommended which not only keep off humidity but also has the effect of electrostatic shielding.

3.4 TEMPERATURE CYCLING FOR STABILIZATION

Temperature cycling for stabilization is the treatment aimed at relieving the mechanical stresses of the assembled inductor.

It is advised that the assembled inductor should be subjected to 0 to 70°C heat cycle of 3 consecutive times minimum. 8 hours minimum per cycle is recommended. This temperature cycle should be performed on the assembled inductor to which the trimmer is inserted and the rough tuning is finished.

MAXIMUM NUMBER OF TURNS ON BOBBINS

MINIATURE POT CORES

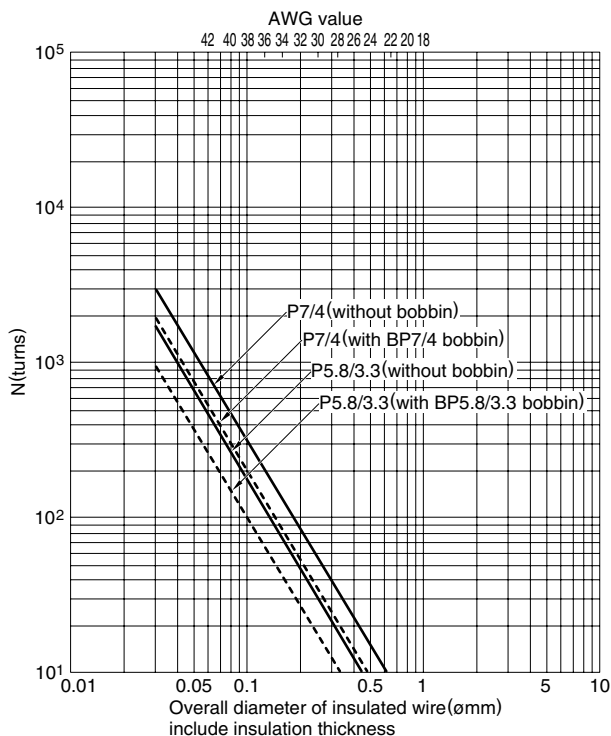

POT CORES

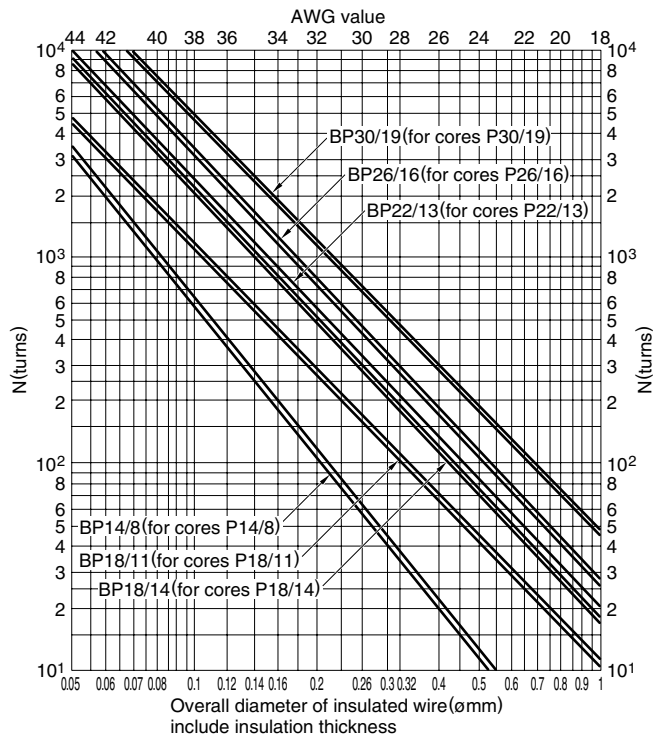

EPC CORES

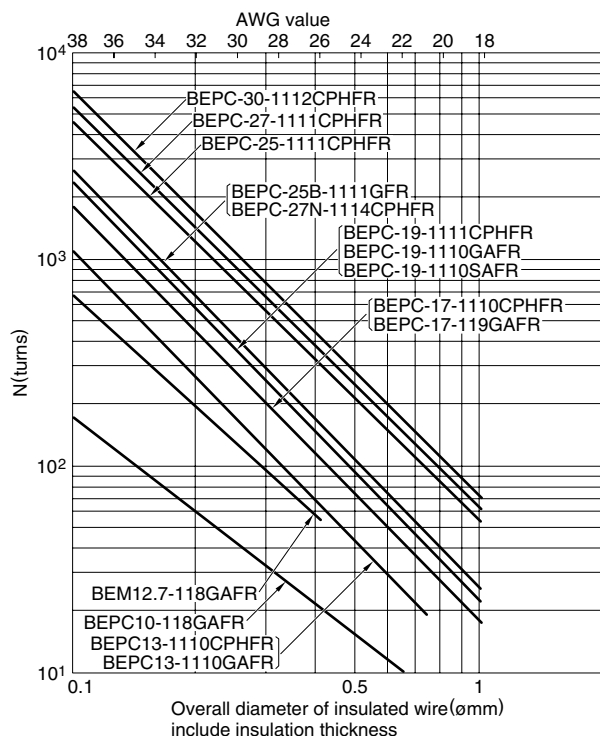

SMD CORES

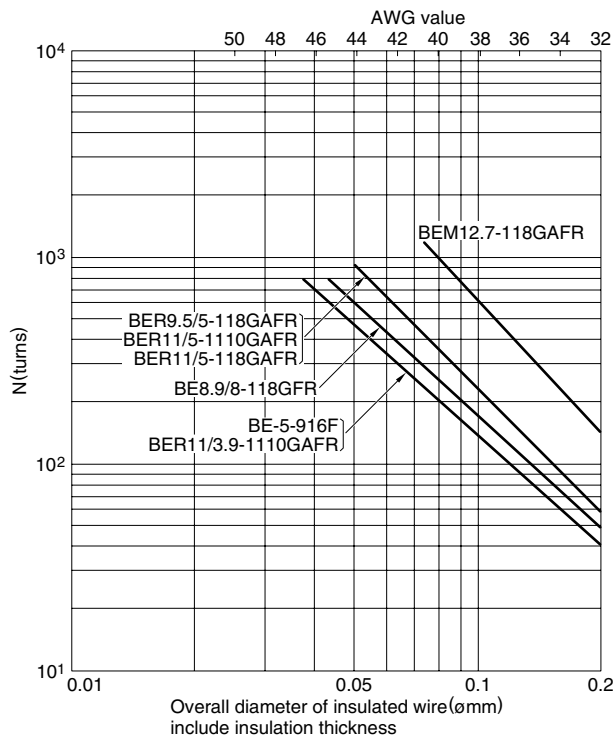

• All specifications are subject to change without notice.

RM CORES

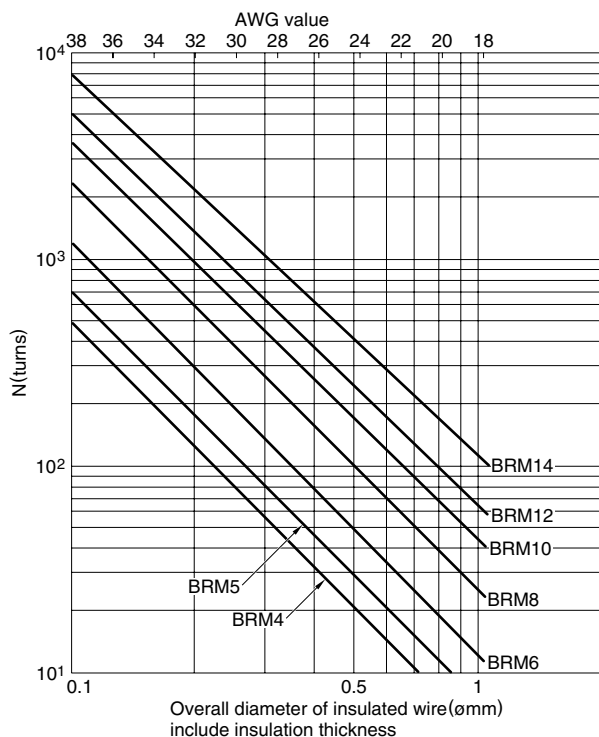

EP CORES

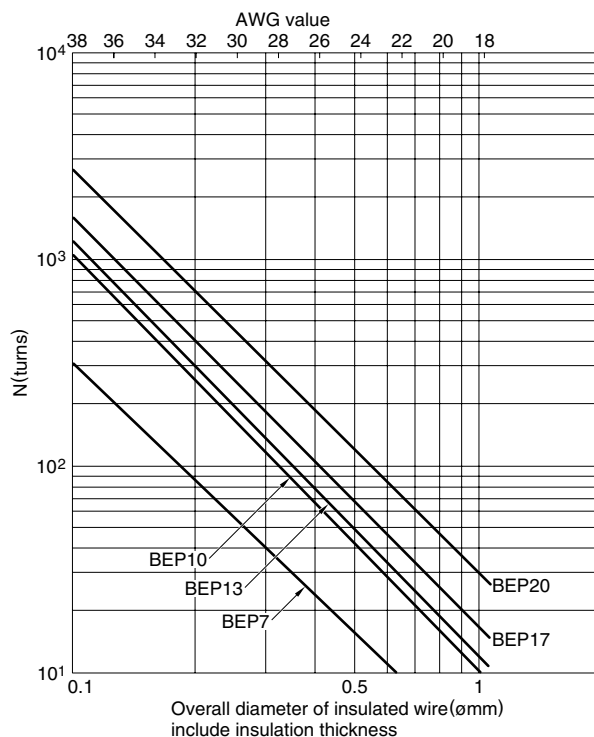

• All specifications are subject to change without notice.